

笠木					
1		2		3	
4		5		6	
7		8		9	
10		11		12	
13		14		15	

支柱					
16		17		18	
19		20		21	
22		23		24	
25		26 溝カバー		27 シャープ用柱	
28		29		30	

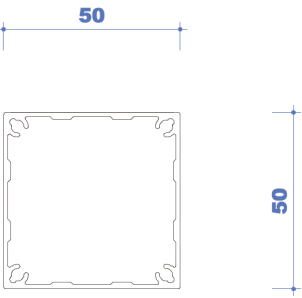
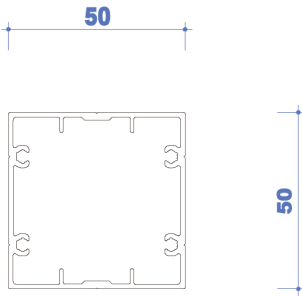
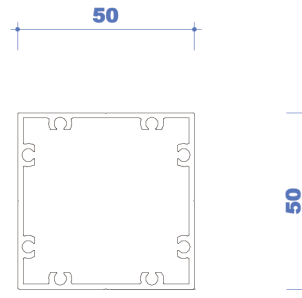
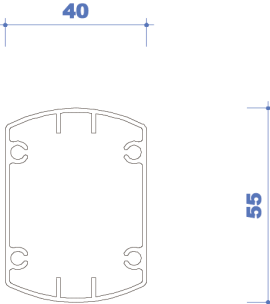
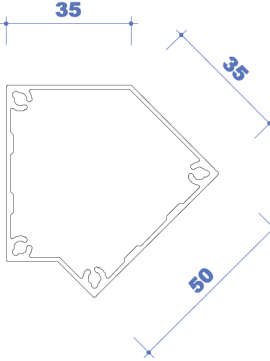
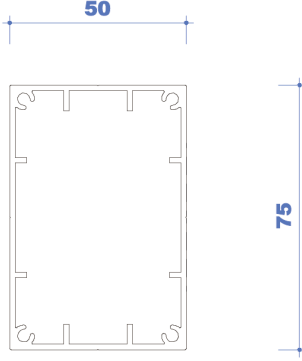
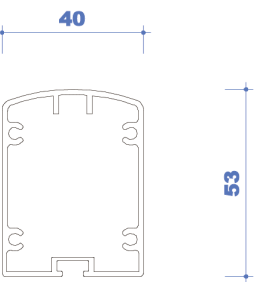
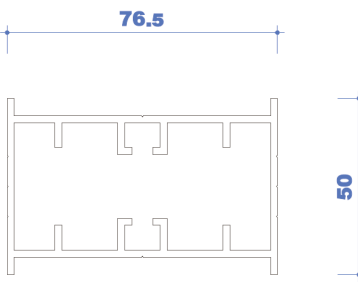
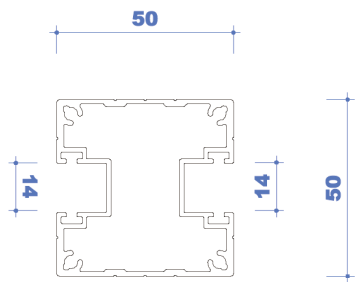
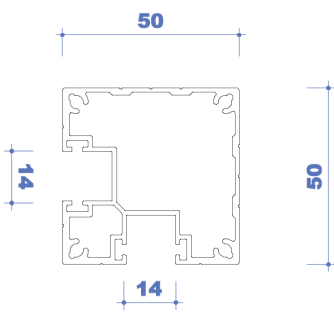
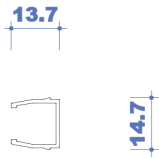
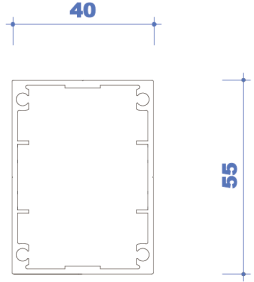

格子					
31		32		33	
34		35		36	
37		38		39	
40		41		42	
43		44		45	

二段笠木

<p>46</p>	<p>47</p>	<p>48</p>
<p>49</p>	<p>50</p>	<p>51</p>
<p>52</p>	<p>53</p>	<p>54</p>
<p>55</p>	<p>56</p>	<p>57</p>
<p>58</p>	<p>59</p>	<p>60</p>

下 枠		
61	下 枠	
62	開口 11.8mm 用	
63	開口 18mm 用	
64	開口 14mm 用	
65		
66		
67		
68		
69		
70	下枠カバー	
71	シャープ下枠	
72		
73		
74		
75		

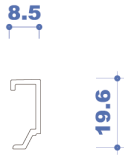
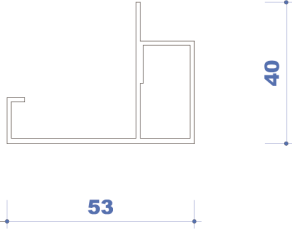
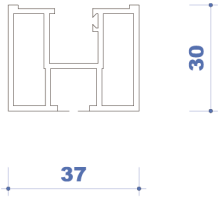
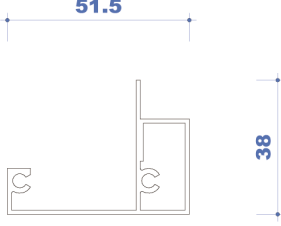
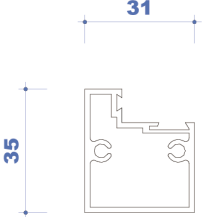
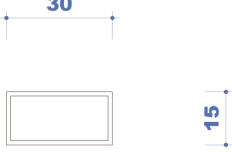
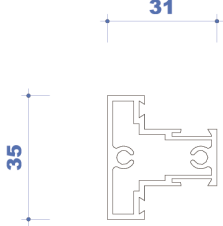
ガラス受材		
76	開口 11.8mm 用	77 開口 14mm 用
ガラスH		
79	開口 16mm 用	80 シャープ G 枠用タテ
		
82		81 シャープジョイント
ガラスH受		
85	開口 11.8mm 用	86 開口 18mm 用
ガラスW		
87		
58	開口 11.8mm 用	59 開口 18mm 用
ガラス押		
60	開口 16mm 用	
		

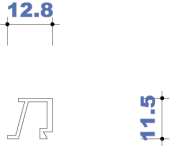
隔材			
91	開口 14mm 用 	92	
94	隔 H 	95	
97	隔 W 	98	
100	隔中棧 	101	
103	隔枠押 	104	
		93	
		96	
		99	
		102	
		105	

クロス材・住宅用面格子		
106	107	108
109 クロス枠	110	111
112 クロス組子	113	114
115 ガラリ羽根	116	117
118 住宅用面格子	119	120
		120

ビル用面格子

121

ビル用面格子

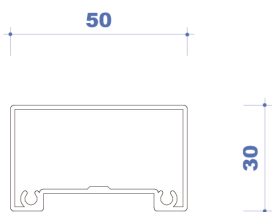

122

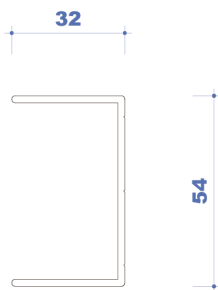

123

124

横格子

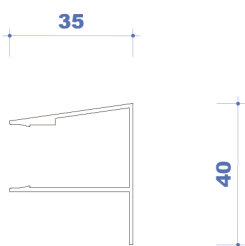

125

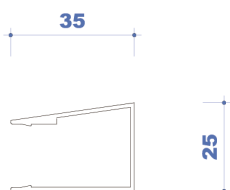

126

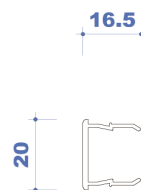

127

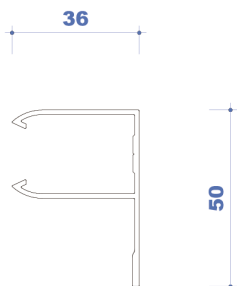

128

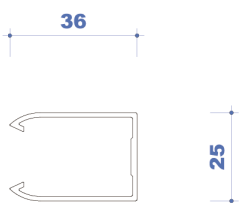

129

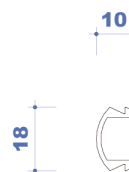

130

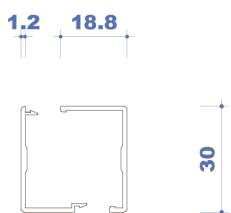

131

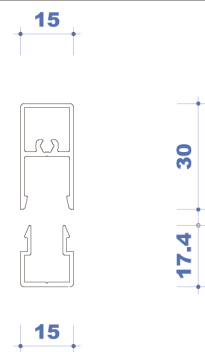

132

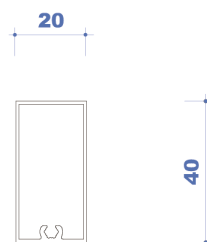

133

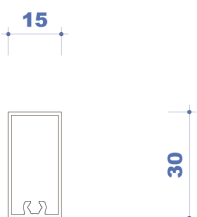

134

横格子 J カバー

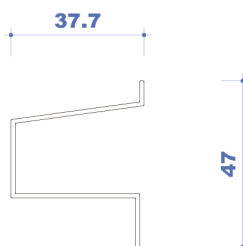

135

エンドカバー



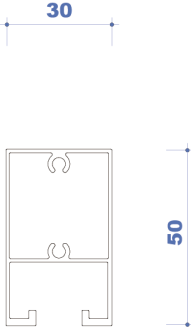
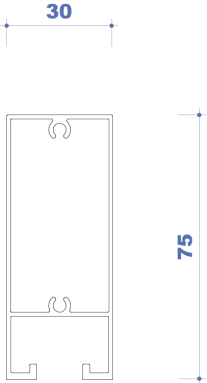
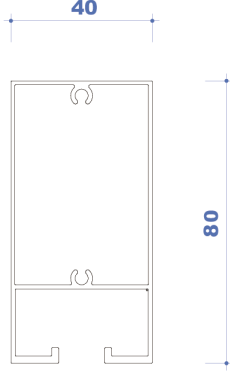
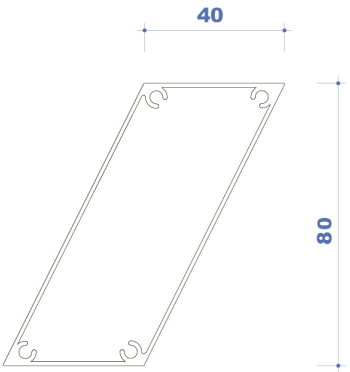
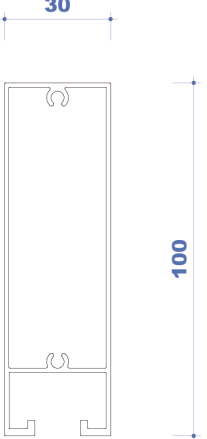
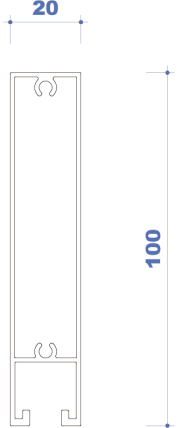
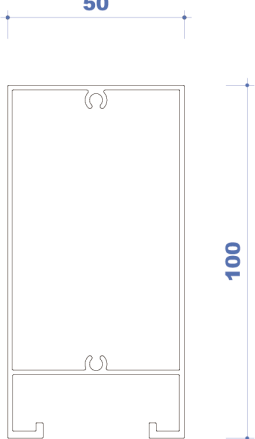
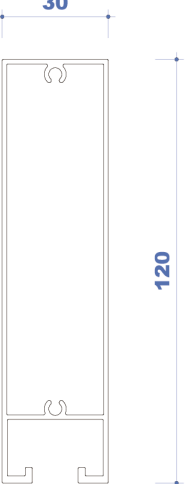
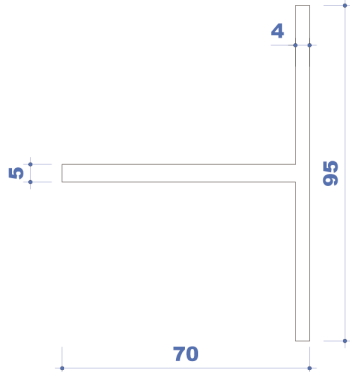

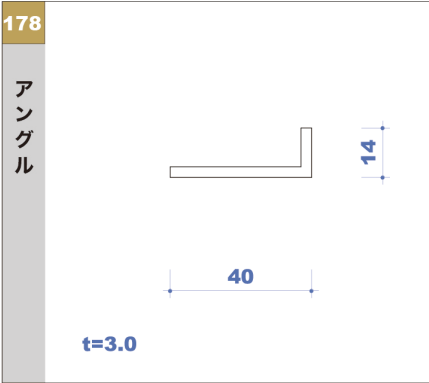
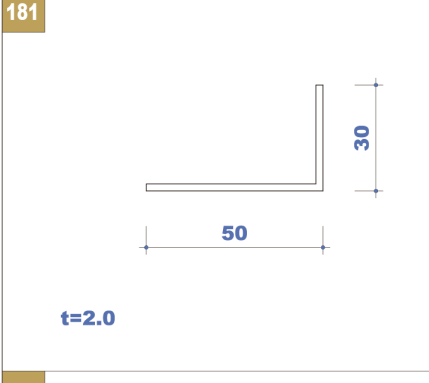
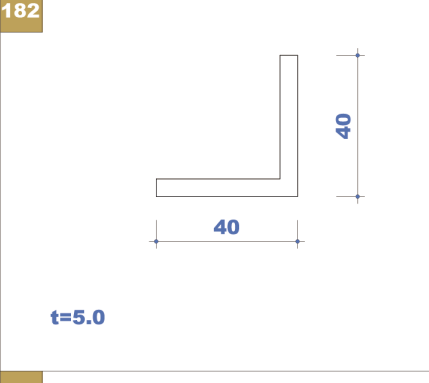
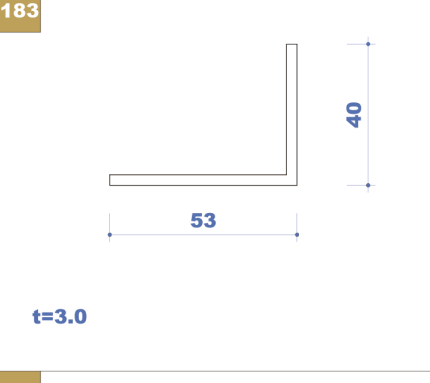
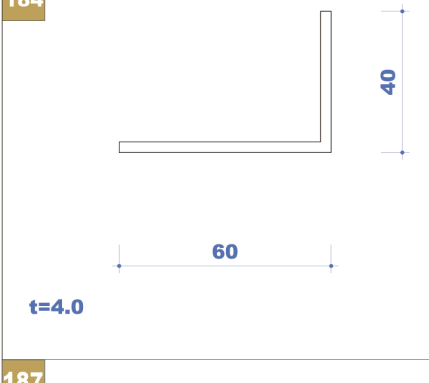
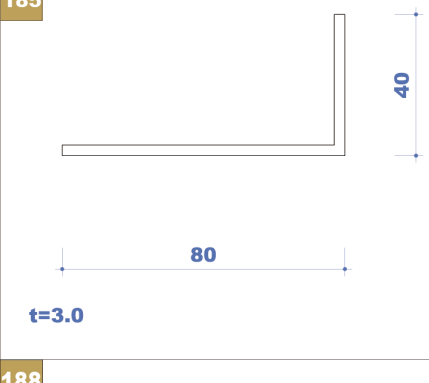
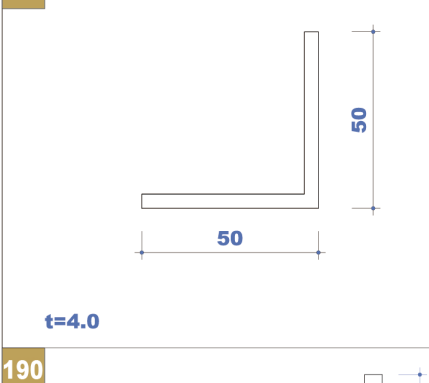
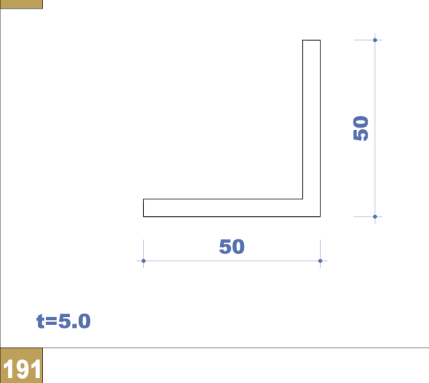
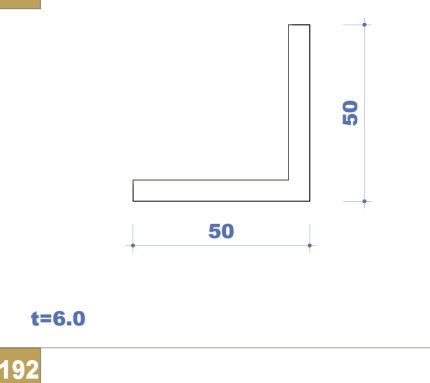
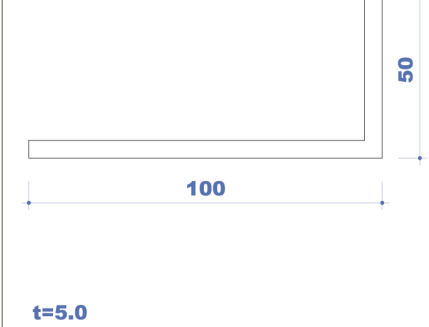

ルーバー材		
136	137	138
139 ルーバー材 	140 	141 
142 	143 	144 
145 	146 	147 ルーバージョイント材 

内部アングル・芯材					
148		149		150	
151		152		153	
154	内部アングル 	155		156	
157	芯材 	158		159	物干補強 
160		161		162	

角パイプ		
163 t=1.5	164 t=1.5	165 t=2.0
166 t=1.5	167 t=2.0	168 t=2.0
169 t=2.0	170 t=2.0	171 t=1.5
172 t=2.0	173 t=2.5	174 t=2.0
175 t=2.0	176	177

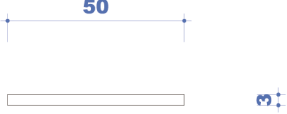
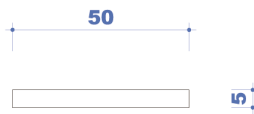
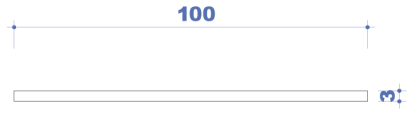
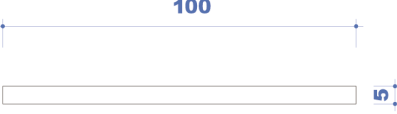
アングル					
178		179		180	
181		182		183	
184		185		186	
187		188		189	
190		191		192	

フラットバー		
193 フラットバー 	194 	195 
196 	197 	198 
199 	200	201
202	203	204
205	206	207

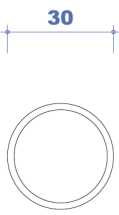
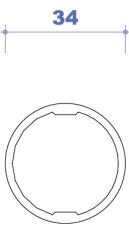
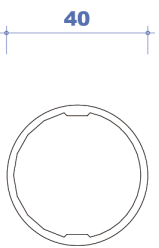
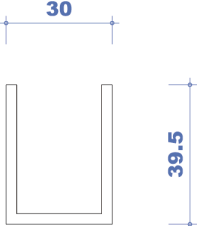
丸パイプ		
<p>208</p> <p>丸パイプ</p>  <p>20</p> <p>t=2.0</p>	<p>209</p>  <p>30</p> <p>t=2.0</p>	<p>210</p>  <p>34</p> <p>t=2.0</p>
<p>211</p>  <p>40</p> <p>t=2.0</p>	<p>212</p>	<p>213</p>
<p>214</p> <p>チャンネル</p>  <p>30</p> <p>39.5</p> <p>t=3.0</p>	<p>215</p>	<p>216</p>
<p>217</p>	<p>218</p>	<p>219</p>
<p>220</p>	<p>221</p>	<p>222</p>

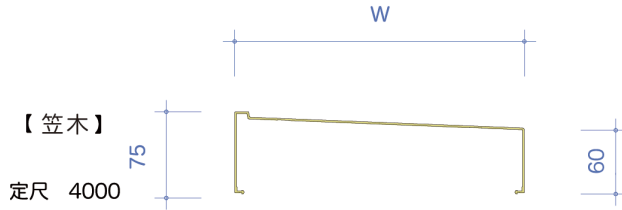

【笠木】

定尺 4000

【ホルダー】

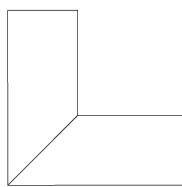

【90°コーナー】

135~300幅 500X500

375~500幅 700X700

550~600幅 800X800

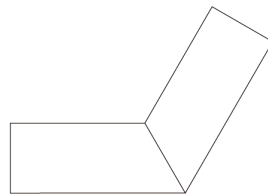

【変形コーナー】

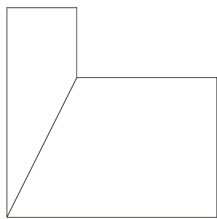

【異形コーナー】

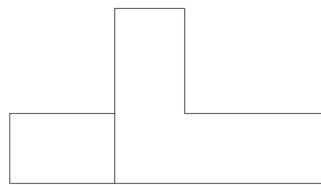

【T形コーナー】

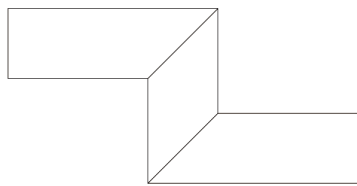

【Z形コーナー】

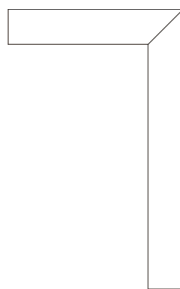

【縦コーナー】



【ジョイナー】



【中間カバー】



【エンドキャップ】

笠木規格幅 x 肉厚 一覧

笠木幅-W	肉厚 (mm)
135	1.2
150	1.3
175	1.3
200	1.4
225	1.5
250	1.7
275	1.8
300	2.0
325	2.2
350	2.3
375	2.4
400	2.5
425	2.0
450	2.0
500	2.0
550	2.0
600	2.0

取付け躯体幅 一覧

笠木幅-W	最適躯体幅-W _B	最大躯体幅-W _M
135	105	112
150	120	127
175	145	152
200	170	177
225	195	200
250	220	225
275	245	250
300	270	275
325	295	300
350	320	325
375	345	350
400	370	375
425	395	400
450	420	425
500	470	475
550	520	525
600	570	575

下端水切

【下端水切】 定尺 4000

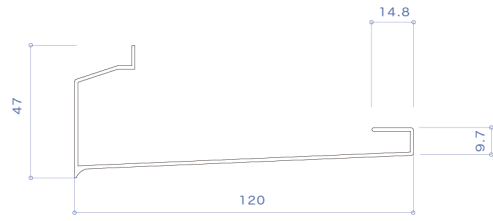
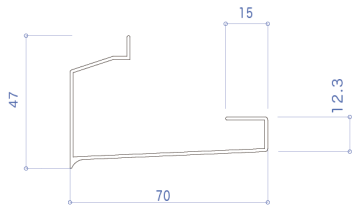

【ホルダー】



【70用】

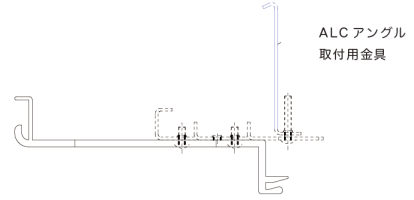

【120用】

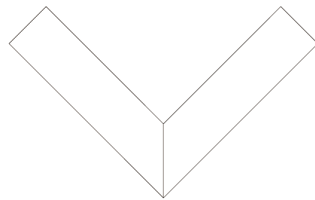

【90度コーナー】

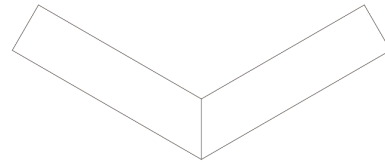

【変形コーナー】

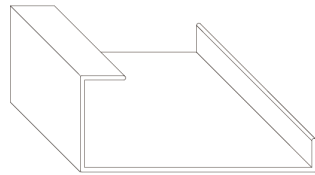

【ジョイナー】

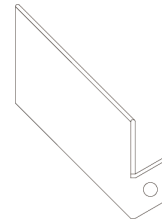

【エンドキャップ】

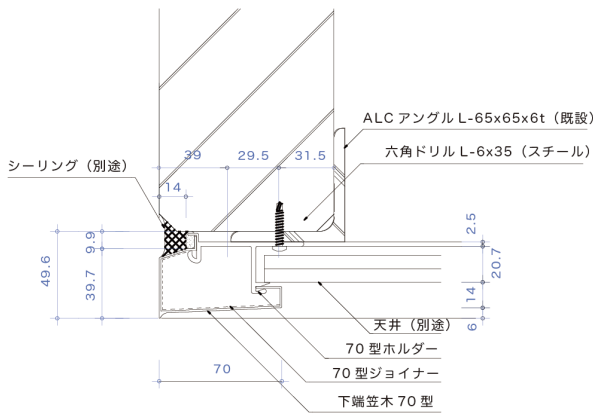

【70用 取付断面図】

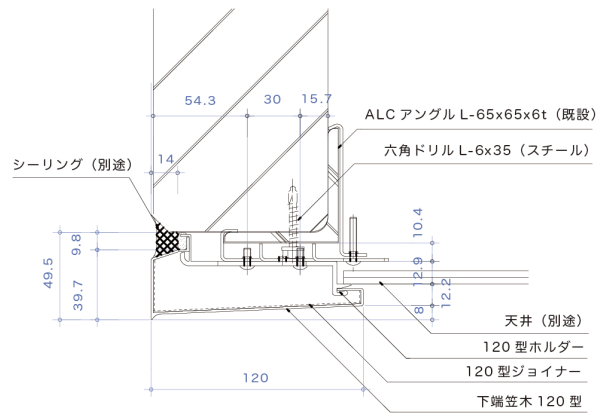

【120用 取付断面図】

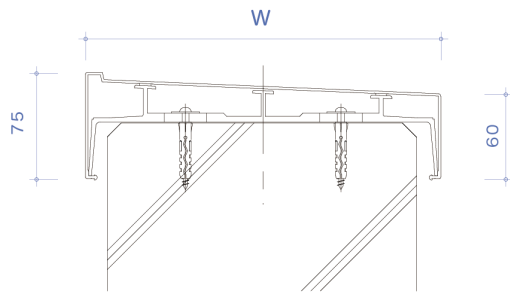

【135~400 型】

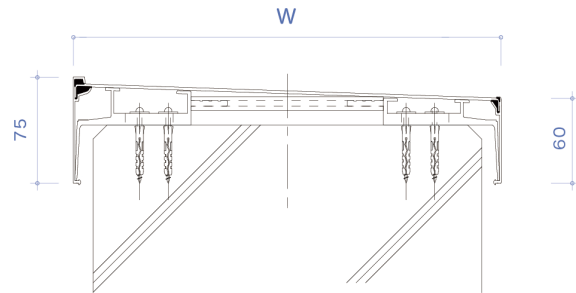

【425~600 型】

形・板曲げスライド 嵌合品

アルミ笠木付手摺

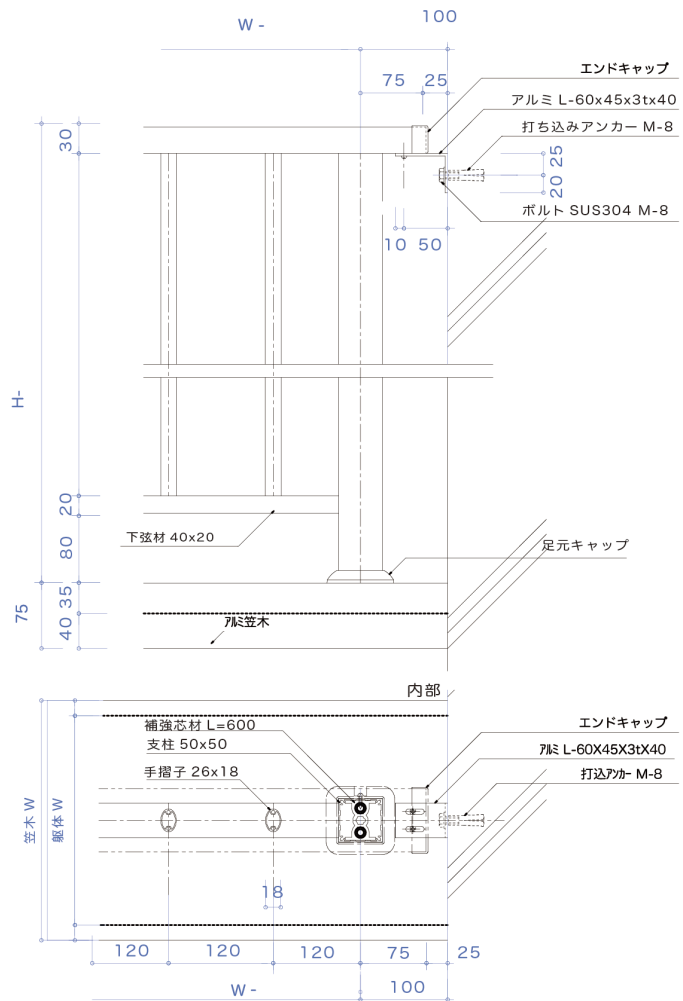
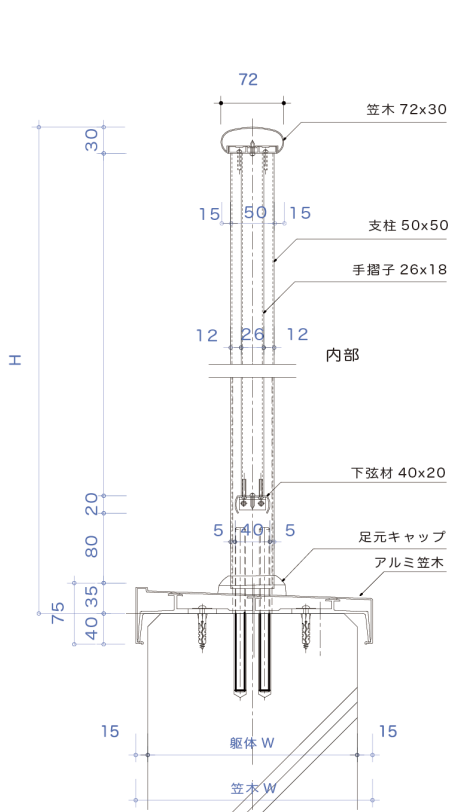

アルミ笠木付手摺

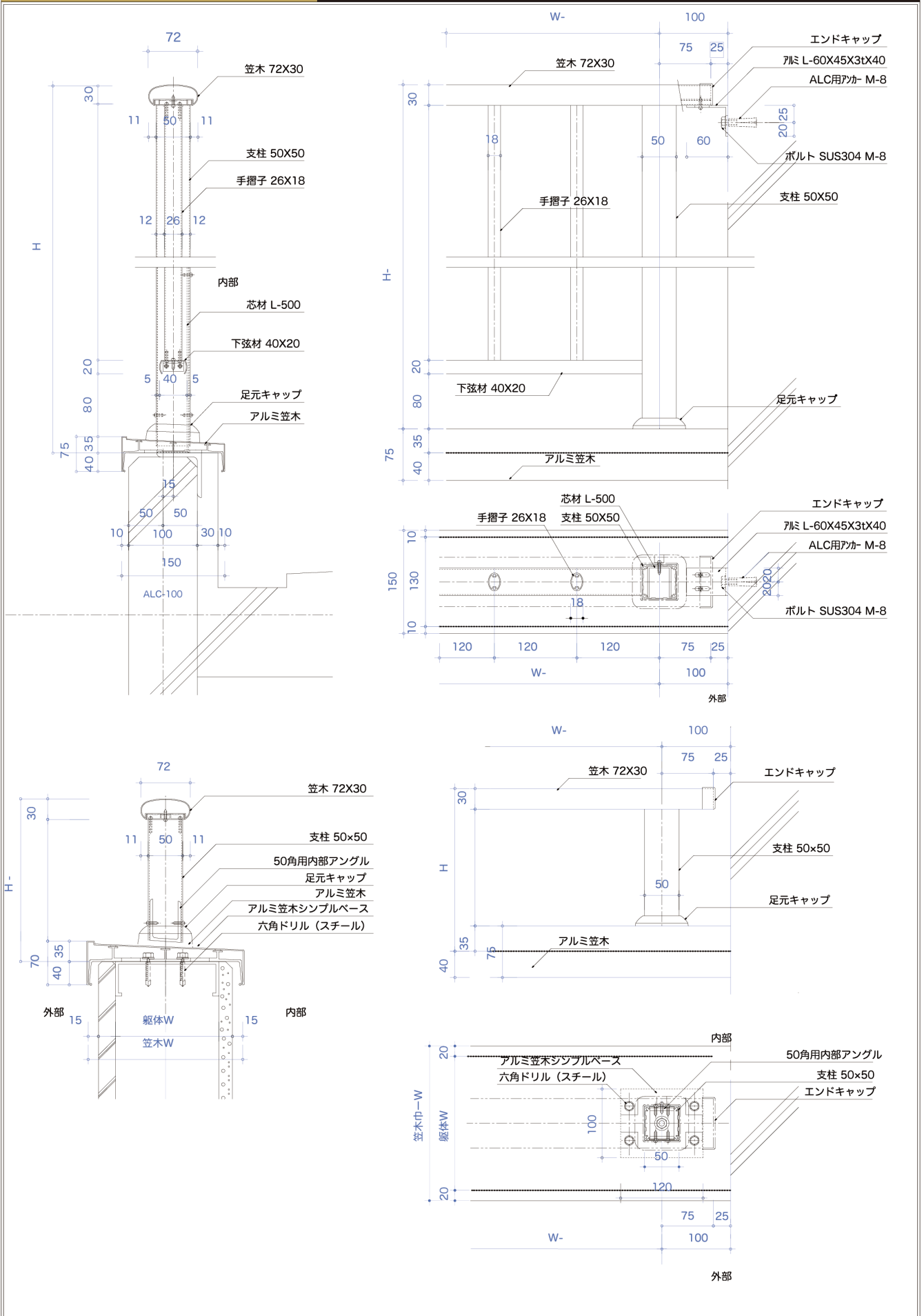

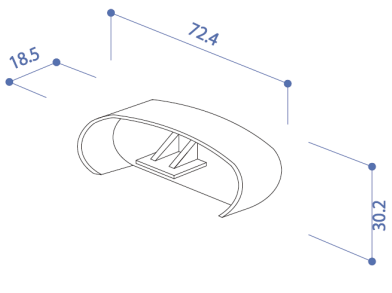
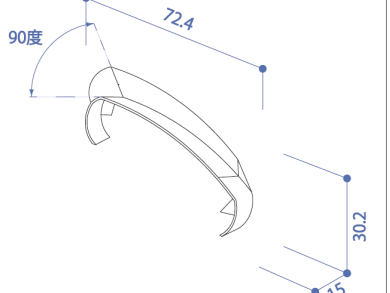
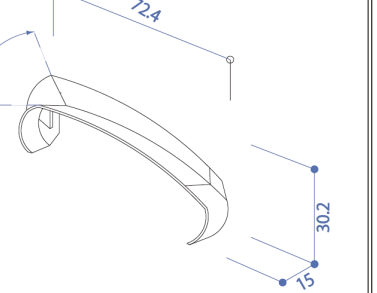
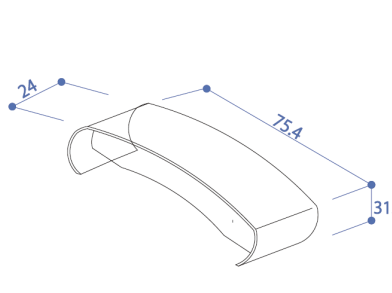
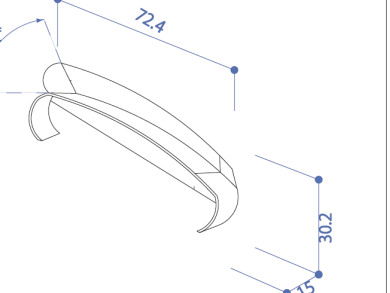
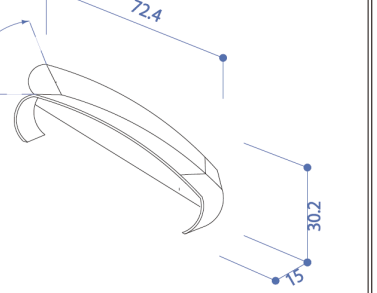
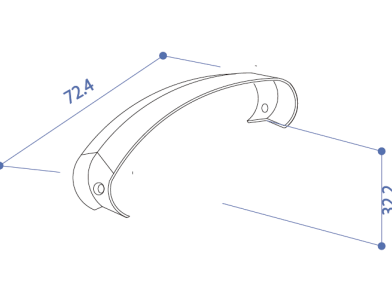
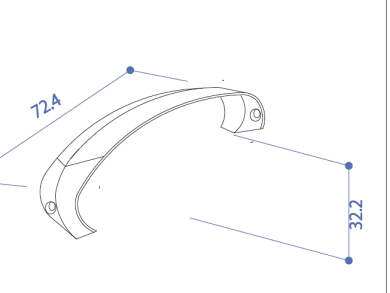
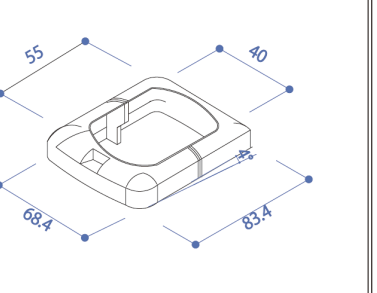
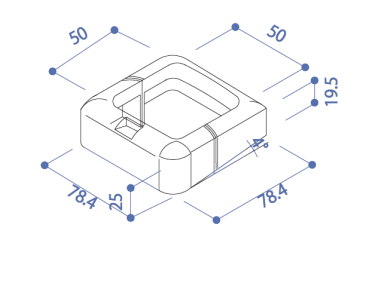
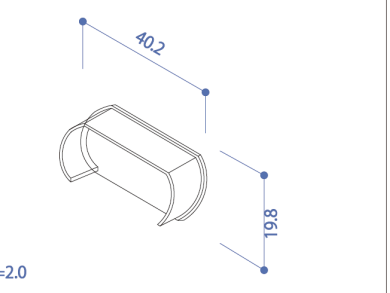
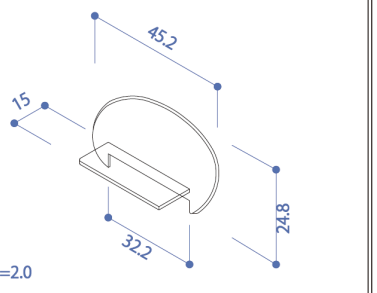
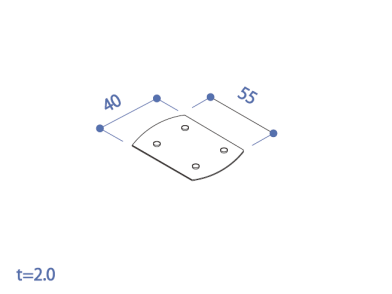
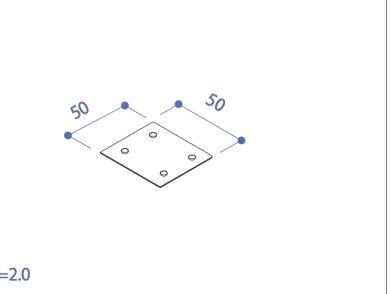
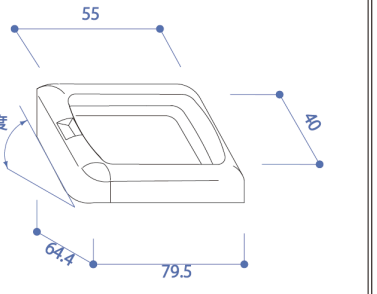
KTS-001~015		
<p>KTS-001 オーバル72 笠木 エンドキャップ</p> 	<p>KTS-002 オーバル72 笠木 90度コーナーキャップ</p> 	<p>KTS-003 オーバル72 笠木 135度コーナーキャップ</p> 
<p>KTS-004 オーバル72 笠木 ジョイントキャップ</p> 	<p>KTS-005 オーバル72 笠木 157度ジョイントキャップ</p> 	<p>KTS-006 オーバル72 笠木 112度ジョイントキャップ</p> 
<p>KTS-007 オーバル72 笠木 階段上リジョイントキャップ</p> 	<p>KTS-008 オーバル72 笠木 階段下リジョイントキャップ</p> 	<p>KTS-009 オーバル 柱 足元キャップ</p> 
<p>KTS-010 50角支柱用 足元キャップ(分割式)</p> 	<p>KTS-011 オーバル 下枠 小口キャップ</p> 	<p>KTS-012 オーバル 二段笠木 小口キャップ</p> 
<p>KTS-013 オーバル 45x55 支柱用 小口キャップ</p> 	<p>KTS-014 50角支柱用 小口キャップ</p> 	<p>KTS-015 オーバル 40x55 支柱用 階段足元キャップ</p> 

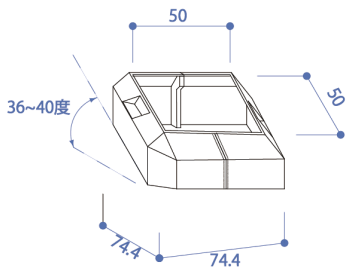
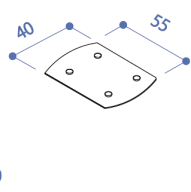
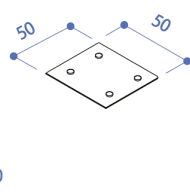
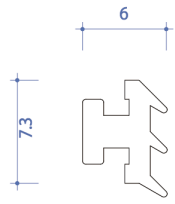
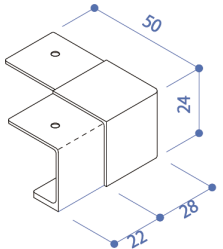
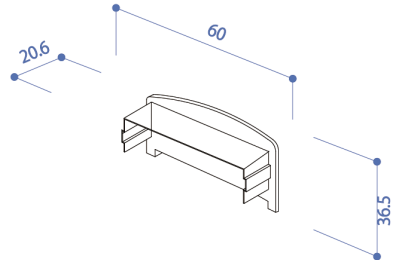
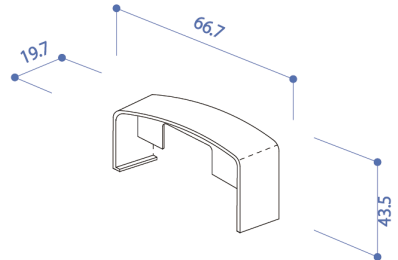
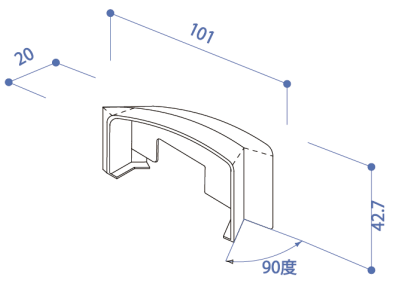
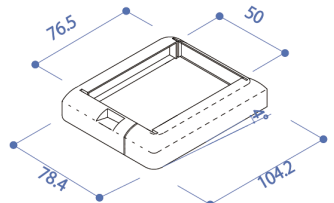
KTS-016~030					
KTS-016	50角支柱用 階段足元キャップ	KTS-017	オーバル 40x55 支柱用 防水パッキン	KTS-018	50角支柱用 防水パッキン
					
KTS-019	先付けビート	KTS-020	クロスコーナーキャップ	KTS-021	60カマボコ型エンドキャップ
					
KTS-022	60カマボコ型Jキャップ	KTS-023	60カマボコ型90度キャップ	KTS-024	方立足元カバー
					
KTS-025		KTS-026		KTS-027	
KTS-028		KTS-029		KTS-030	

KTS-031~045		
KTS-031	オーバル40x55支柱用 ボルト M-12	
KTS-032	オーバル40x55支柱用 ボルト M-16	
KTS-033	オーバル40x55支柱用 ボルト M-18	
KTS-034	オーバル40x55支柱用 ボルト M-20 芯材 L=500 (プレート有)	
KTS-035	オーバル40x55支柱用 ボルト M-20 芯材 L=500 (プレート無)	
KTS-036	50角支柱用 ボルト M-16	
KTS-037	50角支柱用 ボルト M-20 芯材L=500	
KTS-038	50角支柱用 芯材L=500	
KTS-039	オーバル40x55用芯材 (20x40角) L=500	
KTS-040	オーバル40x55用芯材 (20x40角) L=1000	
KTS-041	オーバル40x55用芯材 (20x40角) L=3000	
KTS-042	40x55 鉄プレート	
KTS-043	オーバル40x55用 ボルト M-16 芯材 L=180 (プレート有り)	
KTS-044	オーバル40x55用 ボルト M-16 芯材 L=100	
KTS-045	50角用 M-16 芯材L=250	

KTS-046~060					
KTS-046		KTS-047		KTS-048	
KTS-049		KTS-050		KTS-051	
KTS-052	オーバル40x55支柱用 笠木プレート	KTS-053	50角支柱用 笠木プレート	KTS-054	オーバル72 笠木用 壁付けアングル
KTS-055	オーバル下枠用 アングル	KTS-056	40x55角支柱用 内部アングル	KTS-057	50角支柱用 外部アングル
KTS-058	オーバル40x55支柱用 外部アングル	KTS-059	50角支柱用 90度コーナプレート	KTS-060	ツインアンカー 50角用 L=600

KTS-061~075			
KTS-061	ツインアンカー 40x55角用 L=600	KTS-062	ツインアンカー 50角用 L=300
KTS-063	ツインアンカー 40x55角用 L=300	KTS-064	ツインアンカー 50角用 L=100
KTS-065	ツインアンカー 40x55角用 L=100	KTS-066	小口ブラケット
KTS-067	ルーバー材 小口キャップ 100x50	KTS-068	ルーバー材 小口キャップ 125x30
KTS-069	ルーバー材 小口キャップ 100x30	KTS-070	ルーバー材 小口キャップ 75x30
KTS-071	ルーバー材 小口キャップ 50x30	KTS-072	ルーバー材 小口キャップ 100x20
KTS-073	ルーバー材 小口キャップ 80x40	KTS-074	ルーバー材 小口キャップ 80x40 ひし形
KTS-075	ピルメン小口ふた		

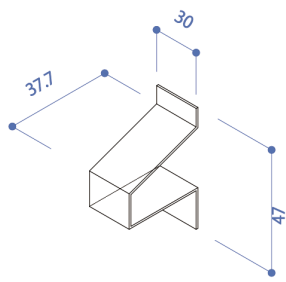
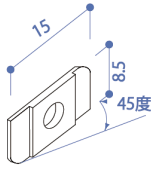
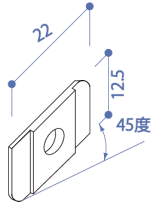
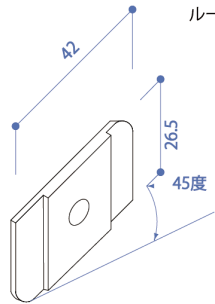
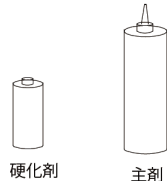
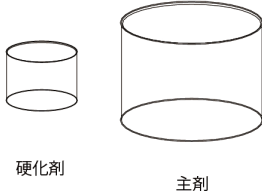
KTS-076~090					
KTS-076	横ルーバージョイントキャップ 	KTS-077	ルーバー裏板(小) ルーバー巾20用 	KTS-078	ルーバー裏板(中) ルーバー巾30用 
KTS-079	ルーバー裏板(大) ルーバー巾50用 	KTS-080		KTS-081	
KTS-082		KTS-083		KTS-084	
KTS-085		KTS-086		KTS-087	
KTS-088	レジン(小) 	KTS-089	レジン(大) 3kg缶 	KTS-090	ケモファスト 